



COMMERCIAL &  
HOME ACCESSORIES

A Division of Penfield Products Inc.

## PRODUCT CATALOG

Call 1-800-265-0041

[www.customhomex.com](http://www.customhomex.com)

- Residential
- Commercial
- Street Signs
- Address Plaques
- Custom Signage





**CBU Color Options**



Sandstone      Black      Postal Grey      Dark Bronze

**Cluster Box Units (CBU)**

Our free-standing, pedestal-mounted, USPS Approved Cluster Box Units (CBUs) provide a safe, secure outdoor solution for your neighborhood's centralized mail delivery needs. Whether you plan to serve 4 or 2,000 residents, cluster box units provide a flexible solution to accommodate your building project needs. Preconfigured units include built-in parcel lockers and outgoing mail collection for added convenience. CBUs can be used alone or in large groupings to accommodate every project type. Each CBU is 30-1/2" wide, 62" high (installed) by 17-7/8" deep. Optional colors: green, white.

**Standard Features:**

- Robotically welded cabinet and hood seams.
- Rugged, weather resistant powder coat finish resists scratching and vandalism.
- Constructed of 300 series stainless steel and aircraft aluminum, including aluminum pedestal.
- Master front loading door designed to prevent prying with interlocking overlap seams.
- Tenant Door 3-3/8" x 12-13/16" Small Parcel Locker 10-1/4" x 12-13/16" Large Parcel Locker.
- Pedestal included with each mailbox purchase.



CBU-8  
Type I  
8 Tenant Doors  
2 Parcel Lockers



CBU-12  
Type II  
12 Tenant Doors  
1 Parcel Locker



CBU-4TS  
Type V  
4 Tenant Doors  
2 Parcel Lockers



CBU-8T6  
Type VI  
8 Tenant Doors  
4 Parcel Lockers



CBU-16  
Type III  
16 Tenant Doors  
2 Parcel Lockers



CBU-13  
Type IV  
13 Tenant Doors  
1 Parcel Locker





Stainless steel hold open door catch on each side of master gate



Easy release handle to open master gate.



Fully integrated parcel locker(s) with key trapping lock



Heavy duty cam latches through frame for added security



Integrated Outgoing Mail Slot with weather protection hood.



Aluminum comb prevents mail fishing from the outgoing mail collection compartment.



**We do installs!**  
 Not only do we sell parcel lockers, CBUs, signs, and site amenities at competitive prices, we are also a licensed California contractor. From our Sacramento Location we are happy to offer installation services throughout California. Our services include, but are not limited to:

- CBU installation
- Mailbox installation
- Concrete pad work
- Wall mount 4C installation
- Street and business sign installation



**Project Planning**

Do you need help with your community, HOA, business mail delivery, way finding or signage needs? Let our knowledgeable team of designers and estimators help. We will provide you with a detailed project outline and accurate estimates. Our detailed site maps and product mock ups will help you to envision the final product, so that nothing is left to chance. With over 25 years' experience working in California's construction trade we will make sure that, where necessary, all building codes, postal requirements and DOT regulations are followed. We are here to help you through all stages of your project's time line.

**Installation**

Custom Home Accessories is a licensed California contractor. We have a skilled and dedicated team of in-house installers and never outsource jobs to cheap third-party labor crews. Our Sacramento based installation team services all Northern California including Lake Tahoe, Redding, San Francisco, the East Bay and greater Bay Area. We are also able to accommodate all of California for larger installation projects. We will happily handle all of your installation needs including concrete pads, multi-unit CBU installation, CBU wall unit installation and post installation.



See Our Website For Pricing  
[customhomex.com](http://customhomex.com)





CC-C1

CC-P128

CC-P114

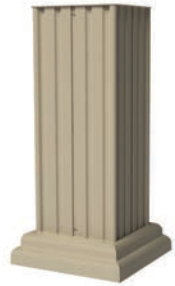

TD-CA



TD-PA28



TD-PA14



**Designer CBU Cap & Pedestal Covers**

These USPS Approved designer caps and pedestal covers offer a quick and easy way to provide a touch of elegance to any centralized cluster box unit (CBU). Dress up a new or existing CBU installation so it matches the surrounding architecture. We offer two distinct design styles in the same powder coat colors as the CBU. These decorative accessories quickly snap together with minimal hardware.

**Standard Features:**

- Rugged, weather-resistant powder coat finish.
- All aluminum construction.
- Easy, snap-together installation with minimal hardware.
- Mix-and-match caps and pedestal cover types to create unique CBU installations.
- Models available for Type V and VI CBUs and Type I and II Outdoor Parcel Lockers.

**Door ID Options**



Decal Numbers  
(1-1/2"H x 1-3/4"W)

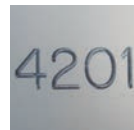

Standard Engraving  
(3/4" H)

Upgrade to a Decorative CBU mailbox system or dress up an older unit!

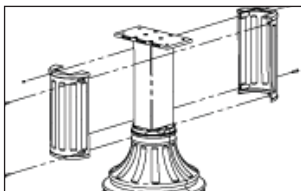
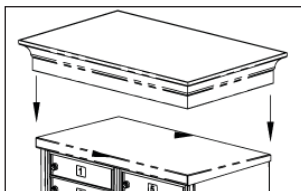

CC-C1-P128-8



CC-C1-P114-16



CC-C1-P128-8



CC-C1-P114-16



TD-CA-PA28-12



TD-CA-PA14-13



TD-CA-PA28-12



TD-CA-PA14-13

**Easy to Install**

Designer caps and pedestal covers snap together with minimal hardware to dress up your existing or new CBU installation.

Order Toll Free: 1-800-265-0041  
Volume Discounts Available





**Regent CBU Mailboxes**

Builders, architects and developers have long been asking for an attractive cluster mailbox. The Regent Collection fills this need by converting a standard USPS cluster box unit (CBU) into an elegant mail center. Constructed of cast aluminum, the USPS Approved Regent is fast and easy to install and will instantly add "curb appeal" to any residential or commercial development. Some existing CBUs can be converted to the Regent style by purchasing the top and pedestal separately. Units come in sandstone, black, or dark bronze.

**Regent Color Options**



**Easy to Install**

Dress up your existing or new CBU installation with easy-to-install Regent tops and pedestal covers.



**Parkview Stucco CBU Cap & Pedestal**

Our Stucco Cap and Pedestal converts a standard USPS CBU mailbox unit into a sophisticated mail center that matches the surrounding architecture. Featuring an exterior-grade stucco surface that is painted to match the CBU, our Cap and Pedestal will add "curb appeal" to any residential or commercial development. Some existing CBUs can be upgraded by purchasing the Cap and Pedestal separately.

**PVSC-TALL** Parkview Cap and Pedestal for 8 or 12 patron box CBU

**PVSC-SHRT** Parkview Cap and Pedestal for 13 or 16 patron box CBU



**Westside Decorative Post CBUs**

Give your development curb appeal with a decorative CBU mailbox and post system. Replace the standard pedestal that comes with your CBU with our attractive and sturdy 4x4 square aluminum posts which are mounted to the sides of your CBU.

Choose from five different finials to top off your posts.

Available in black (custom colors available).

USPS Approval recommended.

**Westside Finial Options**



**B | Outdoor Parcel Lockers**

Used alone or with CBU installations. When tenant accesses compartment, tenant key is captured and retained. USPS Approved. Durable powder-coated finish in all CBU colors. Overall dimensions: Type I 16" x 62" x 18" Type II 30-1/2" x 62" x 18" Compartment dimensions: 12" x 19-3/4" x 15"

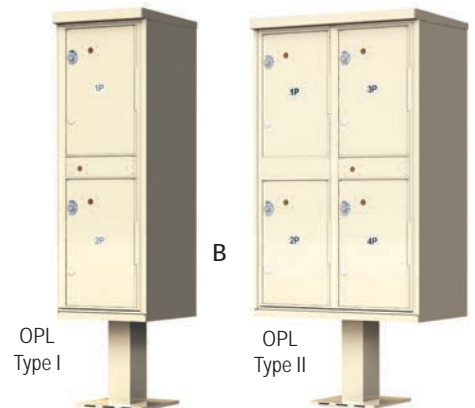

See Our Website For Pricing  
customhomex.com





4C06D-04-P  
4c Pedestal Mount  
4 Tenant Door  
1 Parcel Door



4C09D-16-P  
4c Pedestal Mount  
16 Tenant Door



4C15D-13-P  
4c Pedestal Mount  
11 2H Tenant Door  
2 3H Tenant Door



4C16D-20-P  
4c Pedestal Mount  
20 Tenant Door  
2 Parcel Door



Installation is available on all of our mailbox systems. Call for more information and ask about quantity discounts.



Fully integrated parcel locker(s) with key trapping lock



Easy release handle to open master gate.



Stainless steel hold open door catch on each side of master gate

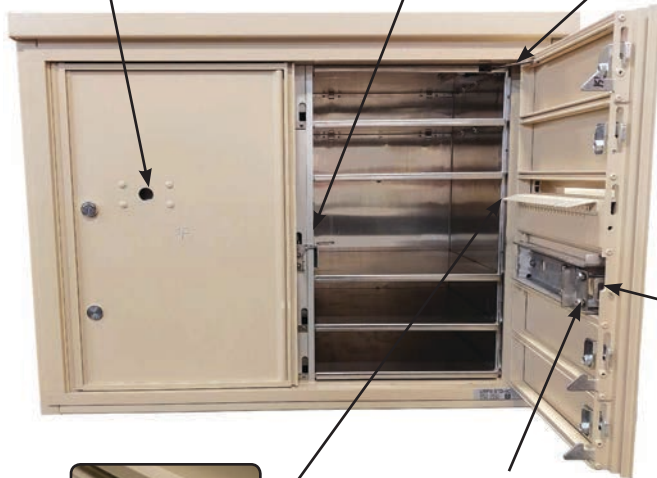

Integrated Outgoing Mail Slot with weather protection hood.



Aluminum comb prevents mail fishing from the outgoing mail collection compartment.



Heavy duty cam latches through frame for added security

#### 4C Pedestal Mount

With all the same features, options, security, and durability of the wall-mounted 4C modules, pedestal mounting simply adds greater flexibility to your project. Designed to ensure every module is at a standard accessible height, pedestal-mount units come prepared with a master commercial lock to provide easy access to all compartments at once. Ideal for centralized mail delivery applications where the USPS letter carrier delivers to a single location and the facility manager or entrusted individual then distributes the mail to the resident compartments.

- Available in single and double wide units.
- Designed exclusively to accommodate USPS Approved 4C mailbox suite modules.
- All aluminum, corrosion resistant construction available in 8 weather resistant powder coat finishes.
- USPS approval recommended before purchase.

#### Pedestal Mount Color Options

Colors shown here may vary slightly due to printing process

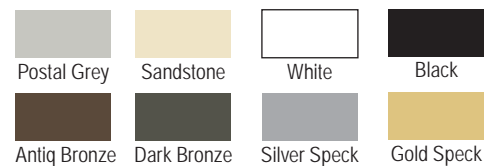

#### Door ID Options



Decal Numbers  
(1-1/2"H x 1-3/4"W)

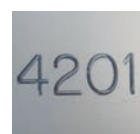

Standard Engraving  
(3/4" H)





**4C Color Options**  
Colors shown here may vary slightly from product

Postal Grey	Sandstone	White	Black
Antiq Bronze	Dark Bronze	Silver Speck	Gold Speck



**Deluxe Powder Coat 4C Mailbox Units**

We have upgraded the security of our USPS Approved horizontal mailboxes to comply with the new USPS 4C standards. Our durable, multi-compartment mailboxes are ideal for apartments and residential/commercial applications.

- Improved lock strength and resistance to the most common methods of attack. All units consist of inner and outer aluminum cabinets, heavy gauge aluminum compartments and doors.
- Powdercoat finish is applied on treated aluminum for a tough, scratch and corrosion resistant surface.
- All hardware and hinges are made of stainless steel.
- Recessed or surface mount available.

**Meets USPS Standard 4C:**

- Upgraded patron lock design.
- Many models are Americans with Disabilities Act (ADA) compliant.
- For indoor and outdoor use.
- Ergonomically designed.
- Solid aluminum mail slot frame design protects adjacent compartments.



**ADA Max Height Suite**

The ADA Max Height Suite is designed to ensure a maximum number of USPS compliant tenant compartments meet Fair Housing ADA installation requirements.



**Design a 4C System to Meet Your Mail Requirements**

Over 130 individual mailbox modules are available, all of which can be customized with oversized doors and lock options for both postal and private delivery applications.

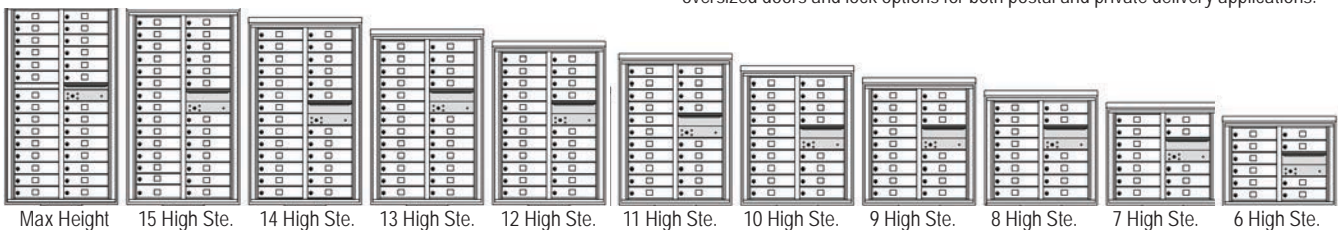





### Premium Anodized

USPS approved manufacturer of STD-4C commercial and residential mailboxes for indoor and outdoor applications. Our architectural grade anodized finishes, come in natural anodized, satin nickel, antique brass and venetian bronze. Our mailboxes can be used for both commercial and residential applications such as offices, high-rise and multi-family. In addition we offer a full line of ADA approved mailboxes for special needs. We offer architects drawing and layout assistance. In addition, we offer a beautiful line of private distribution mailboxes with stainless steel trim. The Max + Parcel Series was created to optimize the mail-room layout while providing parcel lockers to each mailbox cabinet. This series holds the maximum number of tenant doors allowable in each cabinet style with parcel lockers.



Natural Finish

Satin Finish

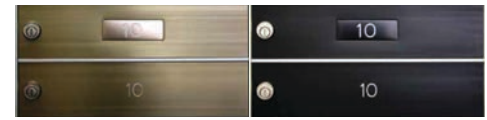

Antique Brass Finish

Venetian Bronze Finish

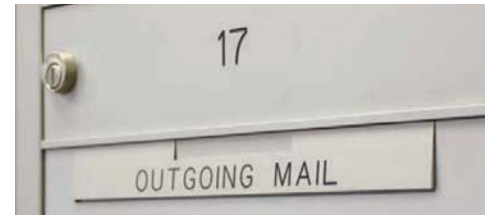

### SINGLE WIDE

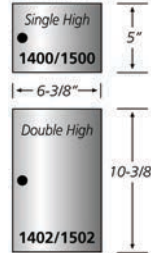

### DOUBLE WIDE

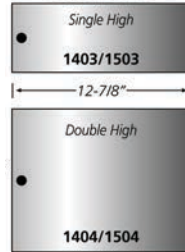

### 4B+ Series Horizontal Mailboxes

- Great for apartments, condos or commercial built-in applications.
- These USPS Approved rugged letterbox units meet or exceed all postal requirements (4B+ compliant)(USPS approved for replacement use only).
- Recess-mounted only, specify front or rear loading.
- Customize by mixing and matching door sizes to meet your needs (call and we will help you with layout).
- Grouped in combinations of 5, 6 or 7 compartments high and 3, 4 or 5 compartments wide.
- Compartments 15-1/2" deep (rear-loading).
- Clear anodized aluminum standard, also available in powder coat colors.



4B+ Front-Loading Horizontal

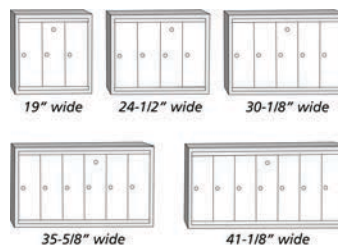

### Vertical Mailboxes

Our USPS Approved (4B+ compliant) Vertical Mailboxes are designed for use in small multi-family apartment buildings. They are constructed of durable, heavy gauge extruded aluminum. A full mounting steel frame ensures complete enclosure of mail compartments. The doors and trim are resistant to scratching. Choose 3, 4, 5, 6 or 7 boxes per unit or add units to meet your needs. All boxes are 19-1/8" high and 7-1/4" deep. Door size: 5-1/2" x 16". Compartment size: 5" x 16-1/2" x 6". Must be protected against the weather. Surface or recessed mount, clear anodized aluminum.

Let our experts design a unique system that meets your special requirements

Order Toll Free: 1-800-265-0041  
Volume Discounts Available



### Package Concierge

Automated package management solutions for apartments, retail, universities and corporate offices. The Package Concierge® locker system is an innovative, safe and efficient way for residents to retrieve and ship packages 24/7. To learn more about installing a Package Concierge® system in your community, contact us for a solution configured specifically to meet your needs.

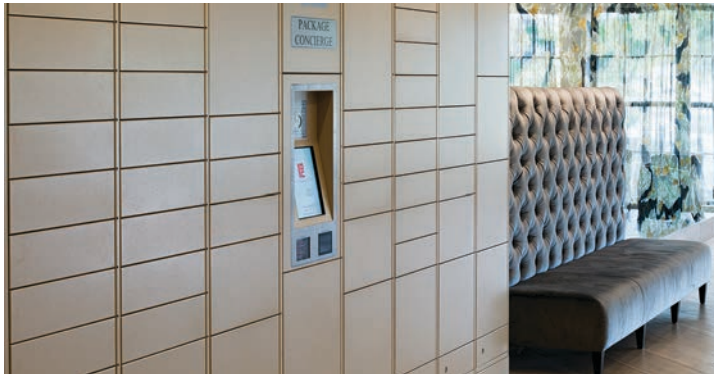

### MyPackageConcierge

Package deliveries to homes continue to grow as on-line purchases are now part of our everyday lifestyle! MyPackageConcierge® provides you a secure place for deliveries to help ensure your packages stay safe and sound while you are away from home. Packages can be delivered by any carrier company you use for on-line order purchases – you control access simply by providing carriers the access code.



Beat the porch pirates!  
Make sure your packages stay safe with our secure delivery systems.



### Havyn Outpost Smart Parcel Locker

10 compartment self-service smart locker system that provides a convenient theft-proof holding area to safeguard packages. The delivery person scans the package label and selects locker bay size. An empty locker door pops open and they place the package inside. Havyn sends a text message to the recipient containing pickup instructions and a unique retrieval QR code. The recipient scans their pickup QR code and the locker bay with their item opens. Delivery complete.





Round Finial Options



Round Pole Shape



Base Options



#7: Ornate #8: Fluted #5: Split Compact #6: Split Short Fluted



### Westside & Builder Series Sign Systems

Let us design a street sign system that not only meets your community signage requirements, but can also match your mailboxes, golf course and directional signs. Our street signs are constructed entirely of aluminum and stainless steel and will not rust or rot.

Street sign blades and frames are made of cast aluminum. Specify either hanging (H) or bolt-on (B). Sign frames for all residential traffic sign shapes can be bolted onto the pole. All signs are built to DOT specs which measure 7' from bottom of first sign to ground unless designated otherwise. Overall height is determined by configuration. Poles come in three lengths: 14', 12', and 11'. Pole diameter is 3" OD or 4" square. Black is the standard color for street sign poles. Custom pole colors available.

We have all grades of DOT sign faces available. Our signs meet current DOT regulations for reflectivity in most communities (higher grade reflectivity available). Just let us know your requirements.

### Sign Frame Options

Handsome recessed frame enhances and protects sign. Frames available for all sign styles and shapes.



Yield Sign Frame



Stop Sign Frame

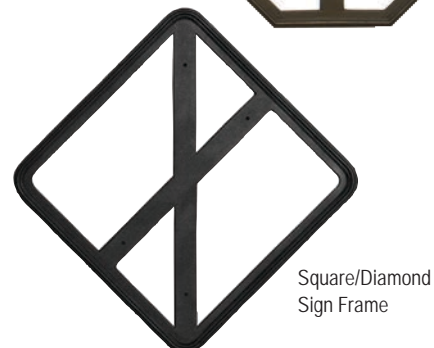

Square/Diamond Sign Frame

Order Toll Free: 1-800-265-0041  
Volume Discounts Available



**Blade Options**

For Round Or Square Sign Pole

SL Bayview Solar Lamp features beveled glass panes with super-bright LEDs (accent only, not for street lighting), 8-1/2" x 19"



RLB Cast Aluminum Raised Letter Blade (bolt-on), 30" x 6", 36" x 6"



BFP Blade Frame Plain: 6"



RLB-LOGO Cast Aluminum Raised Letter Blade (bolt-on) with logo

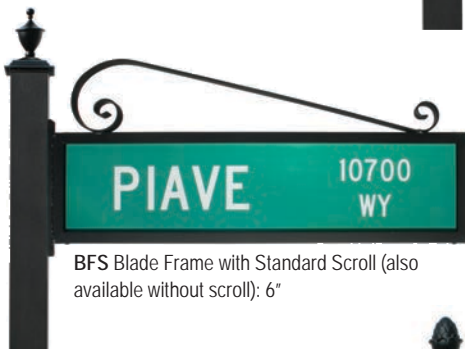

BFS Blade Frame with Standard Scroll (also available without scroll): 6"



DSBF-LOGO Decorative Scroll Blade Frame with Vinyl Logo: 6" mounted top or bottom

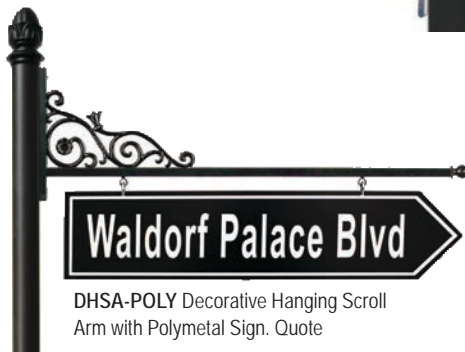

DHSA-POLY Decorative Hanging Scroll Arm with Polymetal Sign. Quote

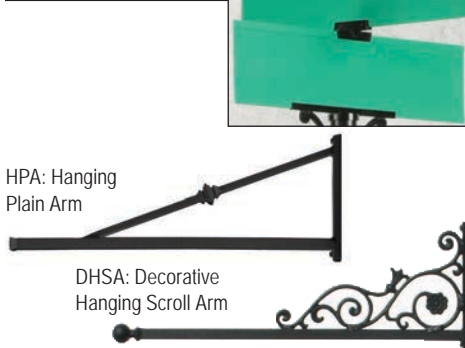
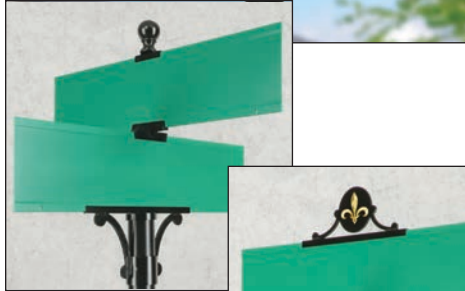

HSA: Hanging Plain Arm

DHSA: Decorative Hanging Scroll Arm

Improve the look and curb appeal of your community or business with updated way finding, decorative mailboxes or custom street signs. We can help you through every stage of your upgrade from bidding the job and site mock up to fabrication and installation. Let us help you reinvigorate your business or community.

**Finial & Post Options**



#SB1: Square Base #SB3: Square Split Base #SC2: Square Collar No Base



See Our Website For Pricing  
customhomex.com





### Decorative Real Estate Sign Systems

Give your premium listings a mark of distinction with our Decorative Real Estate Sign Systems. The quality of our cast aluminum sign posts will elevate your signage above competing wood and vinyl alternatives. Our decorative aluminum post has a durable powder coat finish in black or white. You can mix-and-match posts and finials to create a unique combination. The scroll arm is ready for your hanging sign. Our signs are easy to install with a ground-mounting spike or direct burial base extension.



### Charging Station Pole Mount

While the concept of the electric car is not new, the push for cleaner and more sustainable energy has made plug in cars more popular than ever. Give your parking lot or car port style and distinction with one of our charging station post mounts. Our charging stations are custom designed to fit your tastes. All of our standard base and finial options are available. Height and charging unit mounting can be adjusted to fit your needs. All charging stations are built in house at our Sacramento facility, and can be configured with a number of custom options.

Please call one of our sales representatives for more details and configurations options.

Note: Charging unit is not supplied with the post.

Call or email our sales representatives for more information about charging station options



**Apartment & Building Custom Signs**

We have corrosion free routed PVC and polymetal signs that are ideal for a multiple signage applications. Our solid routed PVC or blasted HDU signs are for inside or outside use. The modern machining techniques used to create these signs creates a look that is similar to old-fashioned hand carved signs, but for much less cost. Our polymetal signs are constructed from a rigid aluminum composite material, consisting of a polyethylene core with aluminum outside faces. The signs are both durable and lightweight with a smooth baked enamel finish. This weather-resistant sign is perfect for outdoor applications. Other color options, different shapes, larger sizes, custom fonts, etc. are available. Please call or email us with your requirements for a custom quote.



**Historical Plaques**

Get the look and elegance of bronze at a fraction of the cost. Our individually hand cast aluminum signs will add style to your project without breaking your budget. Each has deep cast figures and design motifs that are finished in all-weather baked enamel. Mark an entrance, historical house or memorial.

**Bronze-look Plaques:**

- Save up to 70% off solid bronze prices.
- Cast aluminum painted to look like bronze, with a lacquer finish.
- Less likely to be stolen.
- Custom sizes and styles available.
- Old fashioned hand-set look and feel.
- Includes mounting screws.
- Will not rust or rot.







### Custom Metal Letters & Numbers

Metal letters are designed to deliver any message in an unforgettable fashion. This adaptable form of signage is both dynamic and distinctive. Letters can be installed to most any surface and have many options for font and finish. Letter and number types include: sand cast letters, carved prismatic letters, and precision waterjetcut letters. In addition to letters, we can waterjetcut your logo in a variety of materials including brass, bronze, copper, stainless steel and aluminum.



### Entrance Markers

Create an elegant community entrance with a custom sign made from metal, concrete or stone. Each sign is uniquely crafted specific to your requirements. Our design staff can lay out your sign with a logo or other custom art.



### Aluminum Plaques

Get the look and elegance of bronze at a fraction of the cost. Our individually hand cast aluminum signs will add style to your project without breaking your budget. Each has deep cast figures and design motifs that are finished in all-weather baked enamel. Mark an entrance, historical house or memorial.

### Bronze Plaques

The blending of copper and tin to yield bronze first occurred over 5000 years ago. Bronze is vastly more durable and stronger than either of its components, and can be fashioned in limitless forms.







### Etched Plaques & ADA Signage

Our etched plaques are a great option when you need to show fine detail and crisp text. The etching process permits exact reproduction of artwork for interior or exterior applications. Etched plaques are available in aluminum, brass, bronze, copper, muntz metal, zinc and stainless steel.

- A. Oxidized bronze
- B. Satin bronze
- C. Satin bronze with braille and two colors
- D. Zinc silvertone
- E. Zinc with bronze finish and multi-color
- F. Zinc brasstone
- G. Stainless random orbital finish
- H. Zinc bronzetone



Our knowledgeable staff will help you find the ideal plaque that meets your design goals and budget requirements.



We offer a number of different sign material types as well as countless finish options. Call or visit our website for more information on how we can help you with all your sign needs.



### ADA Compliant Signage

Our ADA signage offers beauty, style and compliance in a wide variety of sizes, shapes and colors. Handcrafted from aluminum, zinc, acrylic, wood, polymer and more. We will design and manufacture exactly to your specifications.

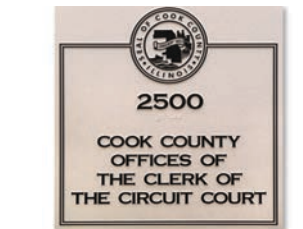

See Our Website For Pricing  
[customhomex.com](http://customhomex.com)



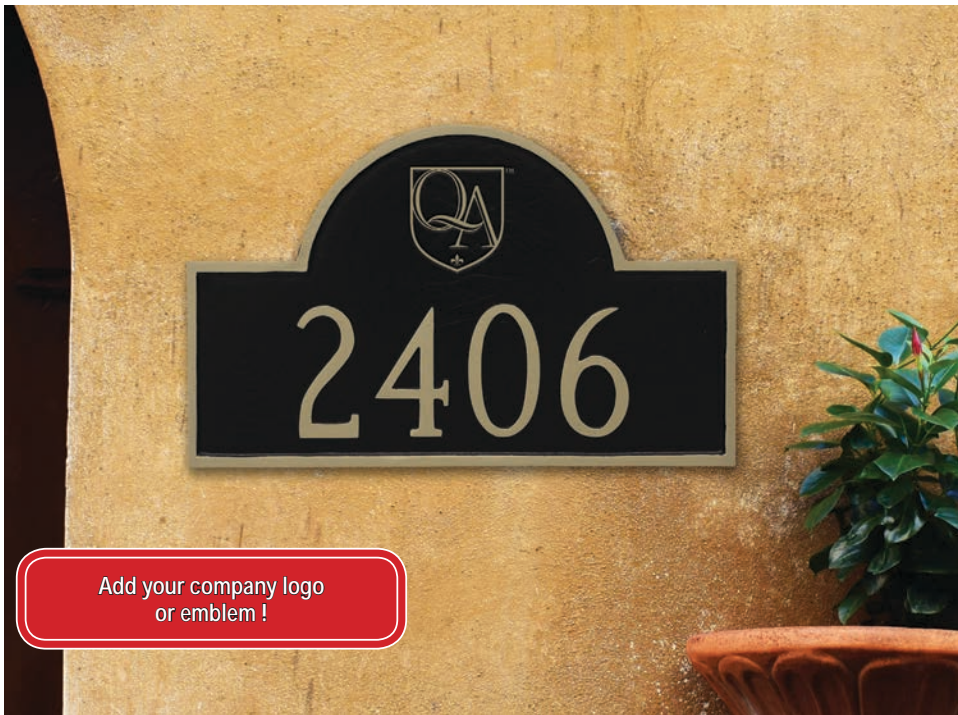

**Custom Aluminum Plaques**

These individually hand cast aluminum address markers reflect traditional good taste. Each has deep cast figures and design motifs that are finished in all-weather baked enamel. Available in several sizes to match your need. Estate size for large homes and lawns, standard for homes and petite for apartments and condos. Most models are available with lawn stakes. Custom designs available. See website for additional color choices and custom lettering.

**Plaque options:** Lawn stake(s). Number and letter sizes are dependent upon the personalization requested. Below is a rough guideline: Most plaques will hold up to 5 large numbers or 17 letters per line. With lettering, the first character is slightly larger than the rest (about 20%). Please note, we can design custom plaques in almost any shape at very reasonable prices. Multiple line plaques also available. See our website for additional details.

**Estate:** single line 5"-8" numbers; double line 4"-5" numbers and 2" letters.

**Large:** single line up to 5" numbers; double line up to 4" numbers and 1-1/4" letters.

**Standard:** single line up to 4" numbers; double line up to 3" numbers and 1-1/4" letters.

**Small:** up to 3" characters.

**Petite:** up to 3" characters.

**Mini:** three 1-1/4" characters.

Add your company logo or emblem!



**Builders & Architects, Personalize Your Address Plaques with a Company Logo**

Ensure lasting recognition of your work by adding a company or community logo to your address plaques. This form of permanent advertising will help establish and grow your brand and remind residents of the contributions you made. Custom plaque shapes, sizes, and colors are available to meet your requirements. Please send us a sample of your logo for a quote.



**Petite Door Number Plaques are Great for Apartments, Condos & Multi-family**

With a wide variety of colors, shapes and styles, you will find the door number plaques you need to fit any decor. Constructed of cast aluminum, our plaques are perfect for hotels, motels, office buildings, schools, apartment buildings, and more. Custom shapes and colors are available to meet your requirements. Please send us a sample of your design for a quote.



**Aluminum Plaque Color Options**

See website for additional color choices.



Ant. Bronze/Gold



Black/Gold



Black/Silver



Black/White



Brick Red/Gold



Chocolate/Gold



Gray/Silver



Hunter Green/Gold



Taupe/White



White/Black



White/Gold





FRMT-11X8 Fairmont



AD52 Colony



AD5 Rectangle

More plaque styles on our website [customhomex.com](http://customhomex.com)



AD-DBL Double Line Standard



AD28 Cut Corner Rectangle



AD47 Prestige Arch



AD60 Vandenberg



AD30 Historical Arch



AD5 Oblong Oval



AD43 Rectangle



AD4 Oval



AD36 Cut Corner Vertical



AD160 Palmont Vertical



AD128 Rockwell Vertical



AD42 Square



AD1 Round



AD53 Montage



AD-1959 Arch with Fleur-de-lis



AD-1971 Rectangle with Scroll

See Our Website For Pricing [customhomex.com](http://customhomex.com)





BSP-3P1



BSP-4P1



BSP-5P1



BSP-2P1



BSP-1P1



WHFEA1



WHFER1



WHFEV1



WHFEO1



### Quick Ship Address Plaques

These attractive plaques are made entirely of cast aluminum (including numbers). 4" numbers, up to 5 digits. Colors: Black/Gold, Bronze/Gold, White/Black, Black/Silver. Custom colors available for large orders. Fast shipping. WATR-REC Waterford Rectangle (13" x 6") CLAR-OVL Claremont Oval (15" x 7") Quick Ship Plaque options: Price includes up to 5 cast aluminum numbers, custom vinyl lettering (up to 3 lines) add.

### Builder Series Address Plaques

Make an elegant statement at a reasonable price. Our traditional plaque designs offer great value along with remarkably fast ship times. Standard finishes ship in about 5 days: Black/Gold, Black/Silver, Black/Copper. Allow 2 weeks for other color combinations. BSP-3P1 Sloped Serpentine (9-3/4" x 6-1/2") BSP-5P1 Deluxe (10" x 6-1/2") BSP-4P1 Arch (9" x 5-1/2") BSP-1P1 Rectangle (9-1/4" x 5") BSP-2P1 Oblong Oval (10-1/4" x 5-3/4")

### Fast & Easy Address Plaques

Give your entryway an affordable makeover. Our Fast & Easy Address Plaques combine popular architectural styling with large 4" numbers for maximum visibility. Choose from 4 different super durable all weather powder coat colors: Black/Gold, Bronze/Gold, Green/Gold, Black/Silver. Easy to order and ultra fast turnaround for these distinctive cast aluminum personalized house number plaques. WHFEA1 Fast & Easy Arch Address Plaque (12" x 7-1/4" x 1/4")(up to 5 digits) WHFER1 Fast & Easy Rectangle Address Plaque (11" x 6-1/4" x 1/4")(up to 5 digits) WHFEO1 Fast & Easy Oval Address Plaque (12" x 6-3/4" x 1/4")(up to 4 digits) WHFEV1 Fast & Easy Vertical Address Plaque (3-1/2" x 19" x 1/4")(up to 4 digits)

### Large Aluminum Address Numbers

Our large address numbers are designed to mark your address in unforgettable fashion. Custom sizes, fonts, colors, and mounting options are available. Please call for details.

- Standard numbers: 4", 6", 8", 10", 12", 16", 20" and 24".
- Traditional or modern fonts.
- Numbers can be are screw mount (flush mount) or stud mount (blind mount) with 1/4" standoff from the wall.

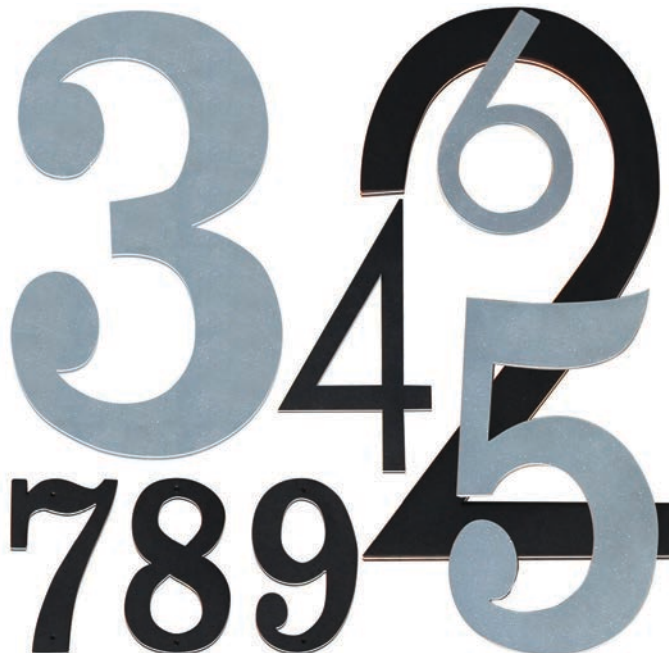

Address numbers can be cut and finished in any style in our in-house fabrication department



**Edgewood Lighted Address Plaque**

The Edgewood has a cast aluminum frame (won't rust or rot) with acrylic lens. Visible up to 100 feet away, day or night. An optional LED back-light is brighter and will last for years. Optional matching raised cast aluminum numbers are available. Easy to install, attaches to existing low voltage doorbell system. Patented design.

LTS-1300 Standard with vinyl numbers (13-1/2" x 7-1/2" x 2-1/2")

LTL-1301 Large with vinyl numbers (13-3/4" x 8-7/8" x 2-1/2")

LTO-1302 Oval with vinyl numbers (14-1/2" x 10-1/2" x 2")

LTV-1303 Vertical with vinyl numbers (7-3/4" x 17-1/2" x 2-1/2")

MIST-1309 The Misty Oak with vinyl numbers (13-3/4" x 9-1/2" x 2-3/4")

Edgewood options: LED back-light, add street name, custom lettering up to 3 lines, 3" cast aluminum numbers, 4" cast aluminum numbers, polished or antique brass numbers.



**Edgewood Frame Finishes**



**Serrano Standard Lighted Address**

Galvanized steel frame with black or bronze powder coat finish. 4" polymer numbers included (optional 4" cast aluminum numbers available). Optional LED back-light is brighter and will last for years.

SRST-AB60 Serrano Standard Lighted Address Plaque (10- 1/2" x 5-1/2" x 2")

**Serrano Extra Large Lighted Address**

Galvanized steel frame with black powder coat finish. 6" vinyl numbers included. Optional LED back-light is brighter and will last for years.

SRXL-AB13 Serrano Extra Large Lighted Address Plaque (14-1/2" x 7-1/2" x 2")



**Edgewood Classic Lighted Address**

The Edgewood Classic has a black, weather resistant, high-impact polymer frame. The deep beveled frame features a rich textured surface. The address is visible up to 100 feet away, day or night. An optional LED back-light is brighter and will last for years. Easy to install, attaches to existing low voltage doorbell system. The do-it-yourself kit has everything you need including raised numbers and mounting hardware. Patented design. Includes 4" raised polymer numbers (0-9 twice), numbers can be attached for a small up-charge.

LTP-1304 (13- 3/4" x 8-7/8" x 2-1/4")



**Serrano Classic Lighted Address Plaque**

Economical ABS molded plastic construction. A simple and modern design that will compliment any home. Tough UV resistant construction will look great for years. Low voltage with optional LED back-light is brighter and longer lasting. Includes 4" raised polymer numbers (0-9 twice), numbers can be attached for a small up-charge.

**Transformers**



FPS-2018 Plug-in



JBX-15951



**Light Bulb Options**

All of our plaques have the option to upgrade to LED bulbs. LED bulbs last longer and are brighter than incandescent light bulbs. Incandescent bulbs will cast a warmer glow while LED bulbs will have a white light.





### Solid Granite Plaques

Make a bold statement with the beauty and timeless look of solid granite. We know how important style is to the appearance of your home or place of business that's why we painstakingly choose only the finest stone to create our plaques from. We only choose granite with beautiful, consistent color that is free of voids or cracks. Our blank granite plaques then become the ideal canvas for your individualized design. We allow you to add your logo, house number or text.

- Made with solid granite
- Deeply engraved
- Number colors: Black, White, Mocha, Gold



Arched Polished Black Granite - White Fill



Oval Polished Black Granite - Gold Fill



Rectangle White Granite - Black Fill



Door Plaque Black Polished - White Fill

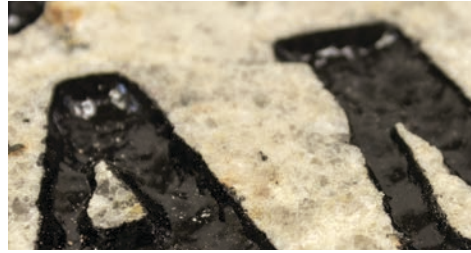

Our Granite plaques are deeply engraved in-house, followed by quality control to bring you the very best product.



Vertical Autumn Leaf



Vertical Black



Vertical Sand Granite



Custom granite plaques for building markers, informational signs and way finding are also available. Please call us for a quote.

### Engraved Cast Concrete Address Blocks

- Cast stone address has deeply etched numbers and letters.
- Lightweight, high quality address blocks are extremely durable.
- Ready for installation in your brick or stone wall.
- Add a graphic to personalize your address block.
- Block finish: Smooth (standard); Travertine (highly textured surface resembles ancient stone) available at additional cost.
- Block colors: Cream (standard); colors including Antique Gray and Burnt Tuscan available at additional cost.

CCAB-ARC Arch (18-1/2" x 12-1/2" x 2-1/2")

CCAB-OVL Oval (17-1/2" x 13-3/4" x 2-1/2")

CCAB-REC Rectangle (15-1/2" x 9-1/2" x 2-1/2")



Travertine Finish

### Block Color Options



Cream



Antique Gray



Burnt Tuscan

Order Toll Free: 1-800-265-0041  
Volume Discounts Available



**Prestige Brass Plaques & Door Knockers**

These lustrous accents are ideal for homes, apartments, offices, condos and hotels. Deeply engraved to your specifications and enamel filled in black, blue, red or white. Engraving style choices: script, block or Old English. Brass plaque choices: polished brass is standard, other finishes available at additional cost. Door knocker choices: polished brass is standard, KV-9020 also available in antique brass, K-9050 also available in polished chrome.



P4002



P5002

P5001

P5003



P7002



P7001



P2002



P2001



P1002



P1001



P4001



P3001



P6001

See our website for more knocker and plaque styles



KV-9020

K-9090

**Winfield Key Keeper**

Convenient way to keep and organize keys. Great way for businesses, car lots, or busy family to keep all their keys in one place. Crafted out of high quality steel with a durable scratch resistant finish that will provide years of trouble free service. Space for up to 8 keys Magnetic Closure Dimensions 6-1/2"W x 9H x 1-5/8"



Color Options

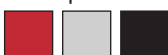

**Freestanding and Wall Mount Ash Receptacle**

Attractive freestanding ashtray box. Made of tough black powder coated galvanized steel for a long service life. Lockable top hides an easily serviceable and cleanable ash and butt catch bin.







### Manchester Column Mounted Mailbox

This decorative cast aluminum mailbox can be easily inset into a column, pilaster or wall. It features a tough powder coat finish in three different colors. Includes oversized masonry box that will hold seven days of mail. Match the Manchester with an optional newspaper box or address plaque. Faceplate: 11-1/4" x 14-1/4" x 1-1/2". Masonry box: 8-3/4" x 12" x 16".

#### Manchester Finish Options



Black

Bronze

Antique Copper



MAN-1403



MAN-1404



MAN-1405



MAN-1406



MAN-1402



MAN-1401

### Manchester Locking Conversion Kit

Locking insert converts non-locking Manchester into a locking mailbox. Made of black powder coated steel. Includes 3 keys.

- Locking door 5" x 5"
- Mail slot: 6"W x 1-1/2"H
- MAN-LCKIT

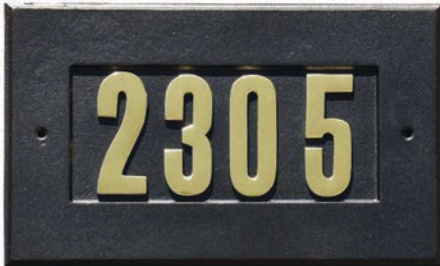

### Manchester Address Plates

Our Manchester Address Plates are a perfect match to our Manchester Mailbox. Cast address plaque with 3" numbers. Dimensions: 11" x 6-1/2"  
ADD-1410-(BL, BZ, AC, RAW)



SSMF Stainless Steel Masonry Flag with bracket allows use of a flag on masonry columns. A great accessory for any column mounted mailbox.



### Manchester Stucco Column

Our stucco column comes ready to install over your 4" x 4" wood post. It has a styrofoam core with a ready-to-paint stucco exterior. As an option, we offer three paint choices: Sandstone, Burnt Tuscan, or Slate Gray. See web-site for full installation instructions. Dimensions: 24" x 24" x 60" (18" x 18" center column).

**MAN-STUCOL** Stucco column (unpainted) with non-locking Arch Column mailbox.

**MAN-S-STUCOL** Stucco column (unpainted) with built in security chute, and Arch Column mailbox.



Sandstone



Burnt Tuscan



Slate Grey



Stucco column ready to install over your 4" x 4" post.



**A | Winchester Column Mount Box**

This mailbox has the "weathered look" that's never out of style. Inset into a column, pilaster or wall. Optional welded address numbers available. Solid brass faceplate is 9-1/2" x 9-5/8", brass box is 8" x 8-7/8" x 17-1/2". Finished in a rich polished patina ("PAP" finish).

**WCH-175** Winchester column mount box

**Winchester options:** Lock option. 3" welded numbers.

**B | Classic Faceplate**

Classic Faceplate of cast aluminum with polished brass accents and aluminum masonry box. Easily inset into a column, pilaster or wall. Faceplate is 14-7/8" x 13-1/8" x 1". Box is 13-1/8" x 11-3/8" x 10".

**CF-S** Classic Faceplate with polished brass accents

**Classic Faceplate options:** Security option. Accents: antique bronze or satin nickel accents.

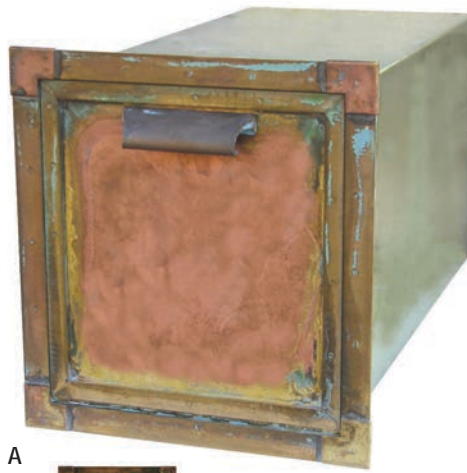

A



B

**Classic Faceplate Color Options**



Black



Metallic Bronze



White



**WCH-175L** Locking option available



3" welded numbers (4-6 weeks delivery)



Antique Bronze

Polished Brass

Satin Nickel

**Lettasafe Collection Boxes**

Made from quality materials and manufactured in England, these large capacity mailboxes offer secure mail storage. The front and rear castings (including the door and flap) are made in English foundries from solid LM6 grade aluminum. The inner compartment sleeve is manufactured from sturdy zinc coated steel, and internal components are made from solid brass or stainless steel. For long life, all metal components are phosphate coated before being finished in a durable top quality powder coat finish. The lock is made from tough black polycarbonate.

**LSF-LS05** Bloomsbury Rear Access Collection Mailbox:

Mounted through a masonry wall or fence, mail is delivered through the front flap and retrieved from the rear lockable secure access door. Bloomsbury mailbox dimensions: 12"W x 17"H x 13"D. Rear access door opening dimensions: 7"W x 7-1/2"H. Incoming opening dimensions: 9"W x 2-1/2"H. Weight: 15 lb. Options: Anti-theft high security plate (HS-PLATE)(slot opening: 9" x 1"). Personalize with your property name or number in vinyl.

**Bloomsbury options:** Vinyl address. Anti-theft high security plate (HS-PLATE).

**LIB-LM6** Liberty Rear Access Collection Mailbox: Mounted through a wall, mail is delivered through a conventional letter plate. The mail then passes through a chute, drops into a collection box and is retrieved from the rear lockable secure access door. The chute depth can be adjusted to match the thickness of your wall. The chute is held in place with masonry and silicone adhesive (not provided). Liberty mailbox dimensions: 11-1/2"W x 16-1/2"H x 14"D. Rear access door opening dimensions: 7"W x 7-1/2"H. Incoming slot opening dimensions: 9"W x 2-1/2"H. Weight: 18 lb. Options: Letter plates available in antique copper, black, bronze or silver. Adjustable chute to match the thickness of your wall.

**Lettasafe Liberty Letter Plates & Chutes**

Liberty letter plates and chutes may be purchased separately for installation into front doors, garage doors, walls or masonry. The letter plate is made from solid aluminum and powder coated in a choice of antique copper, black, bronze or silver. Liberty letter plate dimensions: 12-1/2"W x 5"H x 1"D. Incoming slot opening dimensions: 9"W x 2-1/2"H.

**LM6-AC** Liberty letter plate in Antique Copper

**LM6-BLK** Liberty letter plate in Black

**LM6-BR** Liberty letter plate in Bronze

**LM6-SS** Liberty letter plate in Silver

**LSF-LS10CHA** Liberty 6" chute

**LSF-LS10CHB** Liberty 10" chute



**LSF-LS05**



**LSF-LS03**



Antique Copper



Black



Bronze



Silver

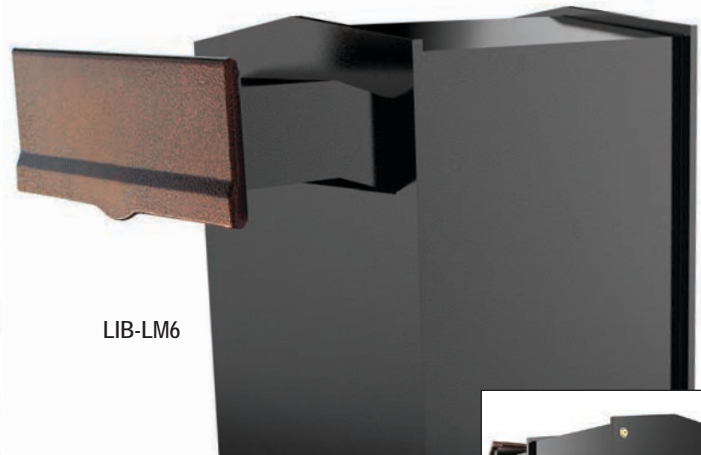

**LIB-LM6**



Letter plate & 10" chute



Rear lockable secure access door



BSMD-804



**Builder Series Mailbox & Posts**

We designed our Builder Series Mailboxes (BSM) with both economy and style in mind. Beautiful cast aluminum provides old world charm at a reasonable price. Mix and match bases and finials to create your own unique look. Choose from the deluxe models with finial and scroll support or the standard models without finial or scroll support. For a finishing touch, add elegant cast aluminum address plates to the sides and front of the mailboxes. Need a custom design? We can custom create a post and mailbox system to meet your needs. BSM mailbox: 8" x 10" x 19".

**Mailbox Post Finial Options:**

Horsehead, Ball, Urn, Acorn, Pineapple Finial and Solar Light Option

**Mailbox Post Base Options:**

Ornate or Fluted Base

**Mailbox Options (See Page #27):**

Builder Series Mailbox, Winchester Mailbox, PV-3000 Mailbox, PV-1000 Mailbox, E-1 Mailbox

**Mailbox Color Options**

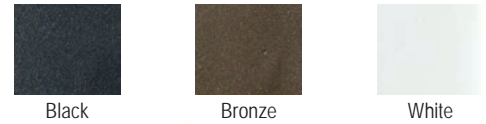

Finial Options

Base Options



#1: Horsehead #3: Pineapple #4: Ball #5: Urn #6: Acorn



#7: Ornate #8: Fluted 6: Split Short Fluted

**Standard Collection**

Made from rust-free cast aluminum with a durable powder coat finish. Mix-and-match bases and mailboxes to create a unique combination. For a finishing touch, add elegant cast aluminum address plates to the sides and front of the mailboxes. Builders and HOAs can personalize their address plates with a custom logo.

**Mailbox Post Base Options:**

Ornate or Fluted Base

**Mailbox Options (See Page #26):**

Builder Series Mailbox, Winchester Mailbox, PV-3000 Mailbox, PV-1000 Mailbox, E-1 Mailbox

**Mailbox Color Options**



Black Bronze White



BSMD-800-SL



BSMD-700-MB3000P



SL



8956-MN94



9066-MN66



BSMD-700



BSS-800-E1



BSMS-800

Order Toll Free: 1-800-265-0041  
Volume Discounts Available



**Westside Square Post Series**

Make a strong statement with our post-and-beam style 4" aluminum square posts. Mailboxes can be mounted on the side or front of the post. BSM mailbox: 8" x 10" x 19".

**Mailbox Post Finial Options:**

Ball, Urn, Pyramid, Pineapple Finial and Solar Light Option

**Mailbox Post Base Options:**

Square Base, Square Collar, No Base

**Mailbox Options (See Page #27):**

Builder Series Mailbox, Winchester Mailbox, PV-3000 Mailbox, PV-1000 Mailbox, E-1 Mailbox

**Mailbox Mounting:**

Front Mount, Side Mount or Top Mounted Mailbox

**Mailbox Color Options**



Black

Bronze

White



WPD-SB1-SL-BSM

WPD-0-S7-BSM



WPD-SB1-BSM



WPD-SB1-S1-BSM



#S7: Pyramid



#S4: Ball



#S3: Pineapple



#S5: Urn



#SB1: Square Base



#SB3: Square Split Base



#SC2: Square Collar



No Base



WSS-SB1-0-BSM



WPD-SB1-BSM

**Custom Coordinate a Master Planned Community**

Our signs, markers and mailboxes can be matched community wide: address plaques, mailboxes, street signs, course markers, club house signs and community entrance signs. Choose from the Builder Series styles on these pages and match with aluminum address plaque styles on pages 16-17.



**Matching Street Signs**

Complete your community with street signs that match the style of your mailboxes. Please see pages 10 for details.

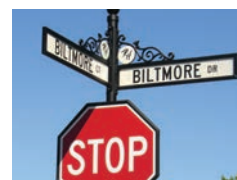

See Our Website For Pricing  
[customhomex.com](http://customhomex.com)





BSCY-4X-804-4850

BSCL-4X-000-BSM



WPDT-SB1-S3-BSM

**Multi-Box Mailbox Units**

We design, and build many of our mailbox system in house. This allows us to tailor our multi-box mailbox systems to suit the needs of our customers. All of our standard mailbox systems can be made into multi-box systems. We can build double, triple, quad systems up to eight box mailbox units using posts, bases and finials from our Builders Series Standard and Westhaven Mailbox systems.

All of our mailbox post systems are customizable. Our fabrication plant can create and or modify any of our systems to fit your community needs.

WPR-2S-SB1-S3-E1



BSPR-15CS-804-E1



BSCY-2X-704-E1



BSMT-800

BSPR-2S-706-E1

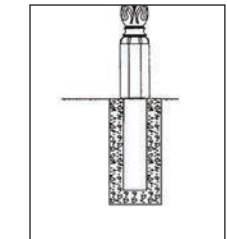

Direct In-ground Base Installation:  
Heavy-duty underground aluminum  
base extension won't rust or rot.

BSCL-2X-700-BSM







BSM

## BUILDER SERIES MAILBOXES

We designed our Builder Series Mailboxes (BSM) with both economy and style in mind. Sturdy cast aluminum provides old world charm at a reasonable price. For a finishing touch, add elegant cast aluminum address plates to the sides and front of the mailboxes. Need a custom design? We can custom create a post and mailbox system to meet your needs.

- Dimensions: 8-1/2" x 10" x 20"
- LM-(BL, BZ, WHT, RAW)

### Mailbox Options:

- Cast Aluminum Address Plate
- Custom Logo Plate
- Custom Vinyl Numbering or Logo
- Locking Security Insert



### Mailbox Color Options

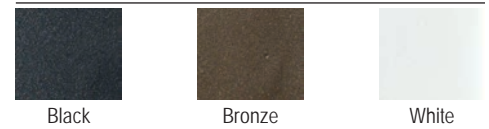

### Winchester Brass Mailbox

We take pride in offering only the highest quality workmanship, resulting in a heavy, solid, refined feel. The Winchester Mailbox for example has over 150 individual spot welds and each component is hand cut. The flags sit straight and the movement is smooth as we insulate the mounting hardware with two nylon sleeves. The door uses a solid continuous hinge and magnetic catch. It has uniform seams and snaps shut, just as you would expect from a well-built automobile.

### Three Sizes:

- Standard 8.5" x 18" x 9"
- Large 10.25" x 20.75" x 11.5"
- Estate 12.5" x 24" x 14.25"

### Winchester Mailbox Options:

- Welded Numbers (4-6 weeks for delivery)
- 2" brass Riveted Numbers
- Locking Security Option



3" welded numbers  
(4-6 weeks delivery)



2" brass riveted numbers



WCH-040 Lock option. USPS approval recommended.

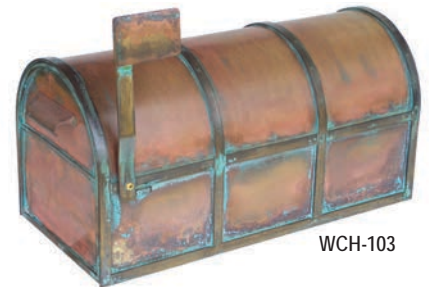
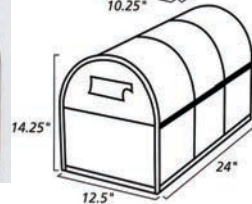
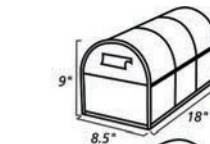

WCH-103



WCHB-104

### MB1000 - Provincial Collection Mailbox

Rustic handcrafted old world charm comes to life in the Provincial Collection. These elegant mailboxes are handcrafted one at a time from heavy gauge brass and copper in the old world tradition.

Dimensions: 7-1/2"W x 8-1/2"H x 18"D



### MB-3000 Mailbox

Rustic handcrafted old world charm comes to life in the Provincial Collection. These elegant mailboxes are handcrafted one at a time from heavy gauge brass in the old world tradition. The MB3000 is available with a patina or polished finish (polished bands and flag).

Dimensions: 8-1/2"W x 9-1/4"H x 19-1/8"D



### E-1 Economy Mailbox

This smooth rust resistant standard size mailbox comes fully assembled with a steel latch and aluminum flag. The door is embossed with the U.S. Flag and Mail and is approved by the postal service.

Dimensions: 6.5"x 19"x 9"



Optional locking insert for the E-1 Mailbox

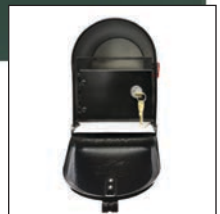

See Our Website For Pricing  
customhomex.com





## The Regal System

The Regal mailbox is of cast aluminum (not sheet metal) that will never rust or rot. These stunning mailboxes were first designed for a unique golf course community and are now found on America's most prestigious home sites. Create your own from the choices on this page. USPS tested and approved. Mailbox: 7-3/4" x 10-1/2" x 19". Post: approximately 60". Black is standard.

### Regal options:

- Bronze, almond, verde, gold verde and green are custom order only
- Newspaper box
- 2" solid brass numbers
- 3" solid brass numbers
- Vinyl numbers on both sides of address plate
- Number plates

### A note about metal casting

Cast aluminum mailboxes are first poured in a sand mould that does not allow perfection in every detail. But that's the appeal of such castings. These "accidentals of art" lend an Old World charm to each piece that no artist could fashion intentionally. In effect, each one is a unique creation. Please note that white highlights imperfections in the casting.

### Builders & HOAs, Personalize Your Mailboxes!

Your logo can be attached to Regal mailboxes. Fax us a sample of your design for a quote.

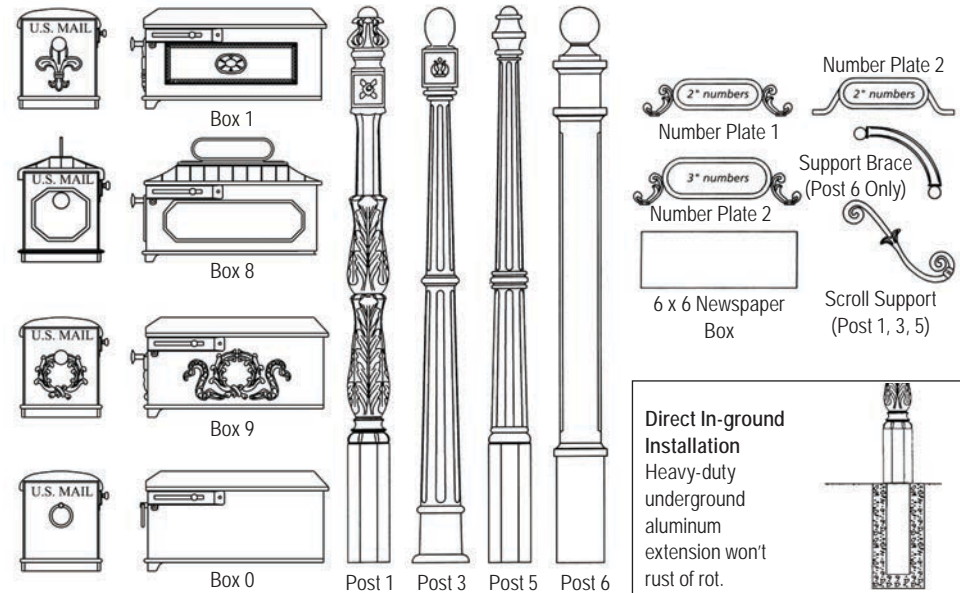

### Regal Color Options

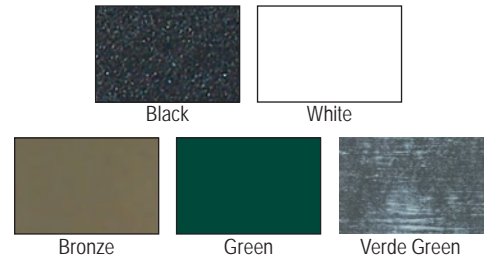

### Keystone Series Mailboxes

Heavy-duty cast aluminum box with a black, metallic bronze, or white powder coat finish. Door accents are available as face plates or script letters in polished brass, satin nickel, or antique bronze. 10-3/8" x 12-1/4" x 20-1/8".

KS Keystone mailbox only (all colors with brass, bronze or satin nickel accents)

KS-SP Keystone standard post (square post only, not shown)(58" high, 4" wide, 4" deep)

KS-DX Keystone deluxe post only

Keystone options: Address plate with vinyl numbers. Newspaper box (KS-NP). Decorative post cuff. Locking insert (KS-LOCK)(USPS approval recommended).

### Classic Collection

Lockable, polished brass door with cast aluminum box. Available with black, metallic bronze, or white powder coat finish. 15" x 50-1/4" x 10". Slot is 9-3/4" x 1-3/8".

CL-S Classic pedestal mailbox

CL-D Classic double pedestal mailbox

Classic options: Address plate with vinyl numbers. Accents: antique bronze or satin nickel accents.



### Mail Handler Locking Mailbox

This locking security mailbox is for those looking for security without breaking the bank. The Mail Handler is made of 14- and 16-gauge galvanized steel, and features a patented anti-pry latch locking mechanism. Baffle door design allows for delivery of small packages without compromising mail security. Durable black powder-coated finish.

- Dimensions 10-3/4" x 11-1/4" x 21"



MBMH

### Package King Locking Mailbox

This USPS Approved large capacity, high security locking mailbox accepts small packages and will securely store weeks of mail. Features patented anti-pry locking mechanism and "Mail Shield" technology which keeps your mail and packages safe from fishing. Made of 12- and 14-gauge electro-galvanized steel construction. Durable powder-coated finish available.

- White, Black or Bronze
- 12" x 16-1/2" x 21-1/2"



MBPK

### LetterSentry Locking Mailbox

This economical locking mailbox features an 18 gauge galvanized steel body and door. It accepts larger pieces of mail and smaller packages. Convenient outgoing tray is also an internal baffle to help keep unwanted hands from reaching into the mail storage area. The LetterSentry can be mounted on most wood posts, the direct burial standard steel post or decorative Westside square post. Durable black powder-coated finish. Vinyl numbering is available.

- Dimensions: 10" wide x 15" high x 19-1/4"
- Standard Post: 48" long x 3" diameter (post is 12 gauge).



LSLM

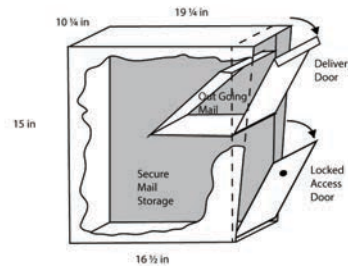

### Vacation Locking Mailbox

This large capacity security mailbox, made of durable powder coated 18-gauge steel, will keep weeks' worth of mail safe. A hinged flap allows you to choose where your mail is delivered. For everyday use, put the hinged flap in the down position, so mail is delivered to the non-locking storage area. When you go on vacation, put the hinged flap in the up position, so mail drops down into the secure locked storage area. The sturdy hinged hopper door is large enough to accept small packages. The locked access door features a hook latch locking system that latches through the frame. The mailbox is labeled inside, providing simple, easy-to-follow instructions for the delivery carrier. Powder coated black finish. Vinyl numbering is available.

- Dimensions: 10-1/4" wide x 29-1/2" high x 23" deep
- Optional 4" x 4" in ground black post (2mm thick)

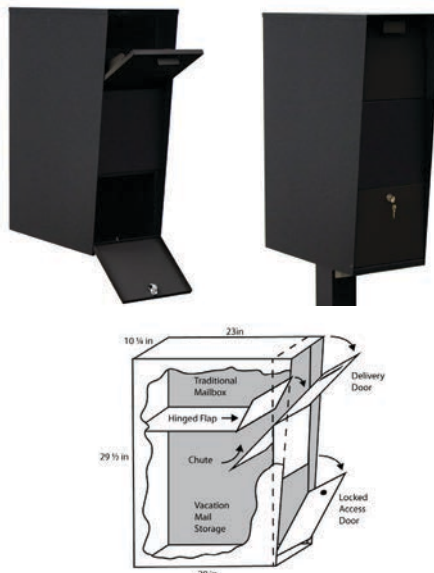

VACMB





A



B

Add a  
Prestige  
Brass  
Plaque



C

**A | Winfield Glacial Locking Wall Mount Mailbox**

Made of stainless steel with a mat finish, it can hold several pieces of mail. Locking door opens in front for easy retrieval. Dimension: 18.5"H x 12.5"W x 5.5"D Incoming slot opening: 10-1/4" x 1"

**B | Winfield Summit Locking Wall Mount Mailbox**

Simple decorative wall mount locking mailbox which features a peaked roof. Mailbox is made of galvanized steel and has a tough black powder coat finish to last many years, front locking door swings open for easy mail retrieval. Dimensions: 13.5"H x 15.5"W x 7.8"D Incoming mail slot opening: 12-7/8" x 1-1/2"

**C | Winfield Ridgeline Locking Wall Mount Mailbox**

Locking wall mount mailbox features a decorative curved roof. Made of tough powder coated galvanized steel, this mailbox is weatherproof keeping contents dry and comes with a weather resistant lock and set of keys. Dimensions: 14.5"H x 14.5"W x 5.5"D Incoming Mail slot opening: 10-3/8" x 1-1/8"

**D | Winfield Woodlake Locking Wall Mount Mailbox**

Large capacity wall mount locking mailbox that comes with a weather resistant lock and set of keys. Mailbox is made of galvanized steel and features a tough black powder coated finish with a stainless steel letter flap and door. Dimensions: 14.5"H x 11.5"W x 5.5"D

**E | Winfield Vista Locking Wall Mount Mailbox**

Top loading mailbox has a modern contemporary design. Weather resistant lock and set of keys included. Box Dimensions: 15.5"H x 11"W x 5.5"D Incoming mail slot is covered by a steel lid, slot opening is: 8-5/8" x 1-1/8"

**F | Winfield Metros Wall Mount Mailbox**

Stainless Steel Vertical Wall Mount Mailbox is a simple top-loading wall mount non-locking mailbox which features a front sliding retrieval door for easy mail access. Mail slot opening: 9-3/8" x 3-3/8" Dimensions: 13.5"H x 9.5"W x 4.5"D

**G | Winfield Compton Locking Wall Mount Mailbox**

Winfield Compton is a simple decorative wall mount locking mailbox which features a curved top. The Winfield Compton is stainless steel and comes with a lock and set of keys. Locking door opens for mail retrieval. Dimensions: 14.5"W x 15"W x 4.5"D Incoming mail slot opening: 13" x 1-3/8"

**H | Winfield Selma Mail/Parcel Box**

Roomy wall mount mail/parcel box which can hold numerous pieces of mail or small parcel packages. Parcel/mailbox is made of galvanized steel with a tough black powder coat finish and features a stainless steel top cover. Dimension: 20.5"H x 17"W x 10"D

**I | Allux 400 Locking Wall Mount Mailbox**

Top-loading, locking, wall mount mailbox. A top lid covers the 12-3/8" x 1-3/8" slot Dimensions: 14-1/8" x 14" x 5-7/8"

**J | Allux LT150 Locking Wall Mount Mailbox**

Simple, locking mailbox is made from powder coated steel. Available in black with gray accent door, galvanized steel or white. Slot Size: 13-5/8" x 1-1/2" Mailbox Size: 15-3/8" x 13" x 5-7/8"

**K | Allux 200 Locking Wall Mount Mailbox**

Rich and roomy, top-loading, locking, wall mount mailbox. A top lid covers the 9-7/8" x 1-1/2" slot. Steel construction with durable powder coated finish. Dimensions: 11" x 15-3/8" x 5-1/2"

**L | Allux 100 Locking Wall Mount Mailbox**

Simple, top-loading, non-locking, wall mount mailbox. Top lid covers the 10-1/8" x 5-7/8" slot. Dimensions: 10-1/4" x 15-3/8" x 6-1/8"



D



E



F



G



H



I



J



K



L

See our website for additional wall mount mailboxes.



**A | Winfield Parcel Defender Mail/Parcel Box**

Built from thick heavy gauge galvanized steel, parcel box has a tough black powder coated finish and locking retrieval door has a handle for easy open and shuts. Parcel opening: 16-1/2" x 13" x 7-1/2" - Dimensions: 15.5"H x 13"W x 6.5"D

**C | ParcelSentry and ParcelSentry Jr. Mail/Parcel Box**

Locking top loading freestanding parcel locker and mailbox features a curved soft closing lid which covers incoming parcel drop opening. Lid is raised up and a steel plate lifts inside with lid, then parcel is placed through top and drops into locking compartment. ParcelSentry 15.5"H x 13"W x 5.5"D - Jr. 20.5"H x 15"W x 10"D

**D | Allux Bjorn Mail/Parcel Box and Bjorn Wall Mount**

Top-loading, locking, parcel mailbox with LED lighting. The LED lighting is activated by a motion sensor or timer. Made of durable black powder coated galvanized steel with Ruko lock. Parcel opening: 12-5/8" x 5-1/4" x 14" Mailbox: 15-3/4" x 43-1/4" x 14-3/8"

**E | Winfield Parcel Box Mail/Parcel Box**

Freestanding parcel locker and mailbox which can hold several small packages and mail. Built from thick heavy gauge steel, parcel box has a tough black powder coated finish and locking retrieval door. Incoming parcel door can receive a maximum parcel size of: 16" x 11-3/4" x 8-1/4" - Parcel opening: 16-1/2" x 13" x 7-1/2" Dimensions: 15.5"H x 13"W x 6.5"D

**F | Parcel Chest Parcel Box**

Our secure home parcel boxes are designed to accept large packages and keep them safe until you get home. Using the box is very simple, just leave the door closed, but unlocked, and any delivery person can place a package into it and lock it. Built from thick, heavy gauge galvanized steel. Medium Dimension: 18"W x 20-1/2"H x 12-3/4"D Large Dimension: 22"W x 24-3/4"H x 17"D



E



C



D



F



Strong and secure package delivery solutions





11300 Trade Center Dr., Ste. A  
Rancho Cordova, CA 95742 USA

For 25 Years, Commercial & Home Accessories has supplied mailbox and signage solutions to HOAs, builders and master planned communities, for HOAs, we will upgrade your community's curb appeal and mailbox security with a single or phased replacement project. For builders and master planned communities, we will design a project where the street signs, entrance signs, address markers and mailboxes are matched community wide.

#### Why Choose Commercial & Home Accessories?

- We have the skill and knowledge to get the job done right the first time.
- We are a factory authorized, licensed, and insured contractor providing full installation services in California.
- We've improved the curb appeal of communities for 25 years.
- We coordinate with the USPS to ensure project compliance.
- We have the expertise to plan and design custom projects.
- We provide professional service before, during and after the installation.
- We have a fully stocked warehouse, ensuring on-time, on-budget installations.

#### Steel Safes

- Solid steel construction with black powder coated finish.
- Pry resistant door has concealed hinges and 2 steel locking bolts.
- Digital combination with 3-8 digit code.
- Time out period after 3 incorrect combination attempts.
- Back-up key included.



#### Weather vanes, Finials and cupolas

Keep a weather-eye on the wind with these three dimensional Weather vanes of sturdy copper with brass fittings.

See our website for over 100 additional styles.

## HOA UPGRADES - NEW COMMUNITY PLANNING - INSTALLATION - CUSTOM OPTIONS

### Commercial & Home Accessories

Toll Free: 1-800-265-0041 • Phone: 916-635-0231

Fax: 916-635-0228 • Email: [info@customhomex.com](mailto:info@customhomex.com)

Web: [www.customhomex.com](http://www.customhomex.com)

11300 Trade Center Drive, Ste. A • Rancho Cordova, CA 95742

Contractor License: #1008664



All dimensions in this catalog are approximate. If your space is critical, call for exact measurements. All personalized and/or customized items are not returnable or refundable. Quantity discounts on prepaid orders only. We shall have the right to refuse or cancel any orders placed for products listed at the incorrect price. See website for most current pricing. All images and products in this catalog are under copyright and/or patent protection. Please see website for additional terms and conditions.

© 2019 Commercial & Home Accessories, a division of Penfield Products Inc.